

Installation manual

Montageanleitung • Notice de montage • Istruzioni per il montaggio • Manual de montaje • Monteringsanvisning •
Installatiegids • Montážní návod • Asennusohje • Installationsmanual

Log cabin PM70-6247

Blockhaus • Maisonnette en poutres • Casa di travi • Casa de jardin • Anneks • Tuinhuis • Zahradní domek •
Timmerstuga • Hirsimökki

Width 620 x Depth 470 cm

Breite/Tiefe • Largeur/Profondeur • Lunghezza/Profondità • Ancho/Profundidad • Bredde/Dybde • Breedte/Diepte
• Šířka/Hloubka • Leveys/Pituus • Bredd/Längd

Log thickness 70 mm

Bohlenstärke • Épaisseur des murs • Spessore delle pareti • Grosor de pared • Tykkelse • Wanddicke • Tloušťka
stěny • Seinän paksuus • Väggtjocklek



The producer shall have the right to make technical changes to the product • Technische Änderungen vorbehalten • Le
producteur réserve le droit d'effectuer des modifications techniques au produit • Il produttore mantiene il diritto di apportare
modifiche tecniche al prodotto • Reservado el derecho a modificaciones técnicas • Produsent forbeholder seg retten til å endre
tekniske egenskaper ved produktet • Alle rechten en technische wijzigingen voorbehouden • Výrobce si vyhrazuje právo na
technické změny výrobku • Valmistaja pidättää oikeuden tehdä tuotteeseen teknisiä muutoksia • Tillverkaren har rätt att utföra
tekniska förändringar för produkten

1 General information



Dear client,

We are glad that you have decided in favour of our garden house!

Please read the assembly manual carefully before proceeding with the house installation! You will thus avoid problems and will not waste time.

Recommendations:

- Keep the house package until its complete assembly in a dry place, but not in direct contact with the ground, protected from weather conditions (moisture, the sun, etc.). Do not keep the house package in a heated room!
- When selecting the garden house location, make sure that the house will not be subjected to extreme weather conditions (areas of strong snowfall or winds); otherwise you should attach the house (for instance, with anchors) to the subsoil.



Warranty

Your house is made from high quality fir and delivered in the natural (unprocessed) form. If, despite our thorough inspection, you should have complaints, please submit the filled out control sheet and purchase invoice to the product seller.

ATTENTION: Please be sure to keep the documentation accompanying the house package! The control sheet includes the control number of the house. We can only review complaints if you submit the control number of the house to the seller!

The warranty does not cover:

- Peculiarities of wood as a natural material
- Wooden details already painted (processed with a wood preservative)
- Wooden details containing whole branches that do not endanger the stability of the house
- Colour tone variations caused by wood structure differences that do not influence wood lifetime
- Wooden details containing (caused by drying) small cracks/gaps that do not pass through and do not influence the structure of the house
- Twisted wooden details if they can nevertheless be installed
- Roof and floor boards that may have on their concealed surfaces some non-planed areas, colour differences and waning
- Complaints resulting from an incompetent manner of the installation of the house or the house subsiding due to an incompetently made foundation
- Complaints caused by introducing self-initiative changes to the house, such as the deformation of wooden details and doors/windows due to an incompetent manner of wood processing; the attachment of storm braces too rigidly, doorframes being screwed onto wall logs, etc.

The complaints covered by the warranty are satisfied to the extent of replacing the deficient/faulty material. All other demands will be excluded!



Garden house painting and maintenance

Wood is a natural material, growing and adapting depending on weather conditions. Large and small cracks, colour tone differences and changes, as well as a changing structure of wood are not errors, but a result of wood growing and a peculiarity of wood as a natural material.

Unprocessed wood (except for foundation joists) becomes greyish after having been left untouched for a while, and can be turn blue and become mouldy. To protect the wooden details of your garden house, you must immediately process them with a wood preservative.

We recommend that you cover the floor boards in advance with a colourless wood impregnation agent, especially the bottom sides of the boards, to which you will no longer have access when the house is assembled. Only this will prevent moisture penetration.

We definitely recommend that you also process the doors and windows with a wood impregnation agent, and do that namely both inside and outside! Otherwise the doors and windows can become twisted.

After the house assembly is completed, we recommend for the conclusive finishing a weather protection paint that will protect wood from moisture and UV radiation.

When painting, use high quality tools and paints, follow the paint application manual and manufacturer's safety and usage instructions. Never paint a surface in strong sunlight or rainy weather. Consult a specialist regarding paints suitable for unprocessed softwood and follow the paint manufacturer's instructions.

Having been properly painted, your garden house's lifetime will increase substantially. We recommend that you inspect the house thoroughly once every six months.

2 Preparation for assembly

Tools and preparation of components

To assemble the garden house, you will need the following tools:



assembly aid



ladder



hammer

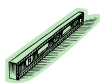

water-level



screwdriver



saw



knife



measuring tape



pliers



drill

ADVICE: To avoid splinters, we recommend that you wear the corresponding protective gloves during the assembly process.



We wish you total success with the garden house installation and much joy with this house for many years to come!

1 Generelles



Sehr geehrter Kunde,

es freut uns, dass Sie sich für unser Gartenhaus entschieden haben!

Es ist wichtig, diese Aufbauanleitung vollständig durchzulesen, bevor Sie mit dem Aufbau Ihres Blockhauses beginnen! So vermeiden Sie Probleme und unnötigen Zeitverlust.

Tipps:

- Lagern Sie den Bausatz bis zur endgültigen Montage trocken und nicht direkt auf dem Erdboden, geschützt vor Witterungseinflüssen (Nässe, Sonneneinwirkung, etc.). Ware bitte nicht in einem geheizten Raum aufbewahren!
- Achten Sie bei der Standortwahl darauf, dass das Blockhaus nicht extremen Witterungsbedingungen (Gebiete mit starkem Wind) ausgesetzt ist, gegebenenfalls sollten Sie das Blockhaus zusätzlich mit dem Fundament verankern.



Gewährleistung

Ihr Haus besteht aus hochwertigem nordischen Fichtenholz und wird unbehandelt geliefert. Wenn es trotz unserer sorgfältigen Werkskontrolle zu Reklamationen kommen sollte, legen Sie Ihrem Fachhändler den ausgefüllten Kontrollschein mit Ihrer Einkaufsrechnung vor!

WICHTIG: Bitte unbedingt die Dokumentation aufbewahren! Auf dem Kontrollschein finden Sie die Kontrollnummer des Hauses. Es ist möglich die Reklamation nur dann als Garantiefall zu behandeln, wenn Sie die Kontrollnummer Ihrem Fachhändler weitergeben!

Abweichungen die keinen Reklamationsgrund darstellen:

- Holz ist ein Naturprodukt, daher gehören die naturgegebenen Beanstandungen nicht unter Garantie.
- Materialreklamationen werden nicht akzeptiert, wenn bereits ein Anstrich erfolgte!
- Äste die mit dem Holz fest verwachsen sind.
- Holzverfärbungen, ohne das dadurch die Lebensdauer beeinflusst wird.
- Risse /Trockenrisse die nicht durchgehend sind und nicht die Konstruktion beeinflussen.
- Verdrehungen des Holzes vorausgesetzt es lässt sich noch verarbeiten.
- An den nicht sichtbaren Seiten von Dach- und Fussbodenbrettern können die Bretter ungehobelt sein, es können Farbunterschiede und Baumkanten vorkommen.
- Spätere Reklamation durch unsachgemässe Montage, Absacken des Hauses durch unsachgemässe Fundamente und Gründungen sind ausgeschlossen.
- Eigene Veränderungen am Haus wie z.B. Verzug von Bohlen und Fenstern/Türen durch fehlenden Holzanstrich oder Aufbau, die zu starre Befestigung der Sturmleiste, Verschrauben der Türrahmen mit den Blockbohlen usw., sind ausgeschlossen.

Ansprüche auf Gewährleistung beschränken sich auf den Austausch von fehlerhaftem Material. Alle weiteren Ansprüche sind ausgeschlossen!



Anstrich und Pflege

Holz ist ein Naturprodukt und arbeitet unterschiedlich. Merkmale wie grobe und feine Maserungen, Farbschattierungen und Veränderungen sowie Verwachsungen haben Ihren Ursprung im Wuchs des Baumes. Sie sind bei Hölzern, die in der freien Natur wachsen, normal und deshalb nicht als Fehler, sondern vielmehr als Eigentümlichkeit des Naturwerkstoffes Holz anzusehen.

Das unbehandelte Holz (ausser Lagerhölzer) wird nach einiger Zeit vergrauen, kann verbläuen und verschimmeln. Um ihr Blockhaus zu schützen, sollten Sie es mit geeigneten Holzschutzmitteln behandeln.

Um Ihr Gartenhaus optimal zu schützen, empfehlen wir die Bodenbretter vorgängig mit einer farblosen Grundierung zu behandeln. Besonders die Unterseite, welche nach der Montage nicht mehr zu erreichen ist. Nur auf diese Weise wird das Eindringen der Feuchtigkeit verhindert.

Wir empfehlen unbedingt auch Türen und Fenster mit einer Grundierung zu behandeln. Es ist sehr wichtig sowohl die Innen- als auch die Aussenseiten der Türen und Fenster auf einmal zu streichen! Andernfalls können sie sich verziehen.

Nach dem Aufbau empfehlen wir Ihnen die Aussenhaut (ohne Dach) zu Grundieren, sobald diese trocken ist sollten Sie das Haus mit einer Holzlasur streichen, die das Holz vor Feuchtigkeit und UV-Strahlung schützt.

Beim Anstrich benutzen Sie hochwertiges Werkzeug und Farbe, beachten Sie die Sicherheits- und Verarbeitungshinweise des Farbenherstellers. Streichen Sie nie in praller Sonne oder beim regnerischen Wetter. Lassen Sie sich ausführlich bei Ihrem Fachhändler über den Holzschutz für unbehandelte Nadelhölzer beraten.

Durch einen regelmässigen Anstrich beeinflussen Sie im Wesentlichen die Lebensdauer Ihres Gartenhauses. Wir empfehlen Ihnen auch eine halbjährliche Inspektion des Gartenhauses.

2 Vorbereitung zur Aufbau

Werkzeuge und Vorbereitung der Details

Beim Aufbau brauchen Sie Folgendes:



Montagehelfer



Stehleiter



Hammer



Wasserwaage



Schraubenzieher



Säge



Messer



Bandmass



Zange



Bohrer

HINWEIS: Um Verletzungen durch eventuelle Holzsplitter zu vermeiden, tragen Sie bitte während der Montage entsprechende Schutzhandschuhe.



Wir wünschen Ihnen nun viel Spass und Erfolg beim Aufbau und jahrelange Freude mit Ihrem Gartenhaus!

1 Généralités



Cher client,

Nous sommes heureux que votre choix se soit porté sur notre maison de jardin!

Il est important de lire entièrement cette notice de montage avant de commencer la construction de votre maisonnette en poutres! Vous vous éviterez ainsi des problèmes et des pertes de temps inutiles.

Conseils:

- Avant son montage définitif, entreposez le kit de construction au sec et pas directement sur la terre, en le protégeant contre les intempéries (humidité, rayonnement du soleil, etc.). Ne pas conserver la marchandise dans un local chauffé!
- Au moment de choisir l'endroit de montage, veillez à ce que la maisonnette en poutres ne soit pas exposée à des conditions atmosphériques extrêmes (zones exposées à des vents forts). Le cas échéant, il serait bon d'ancrer la maisonnette en poutres dans des fondations.



Garantie

Votre maisonnette est réalisée en bois d'épicéa nordique de haute qualité et elle vous est livrée non traitée. Si elle devait donner lieu à des réclamations, malgré les soins apportés à notre contrôle en usine, nous vous demandons de remettre à votre revendeur spécialisé le bon de contrôle rempli et votre facture d'achat!

IMPORTANT: Veuillez impérativement conserver la documentation! Vous trouverez sur le bon de contrôle le numéro de contrôle de la maisonnette. La réclamation ne peut être traitée dans le cadre de la garantie que si vous communiquez le numéro de contrôle à votre revendeur spécialisé!

Ecartis qui ne constituent pas un motif de réclamation:

- Le bois est un produit naturel, ce qui fait que les réclamations reposant sur des phénomènes naturels ne tombent pas sous le coup de la garantie.
- Les réclamations concernant les matériaux ne sont pas acceptées si une peinture a déjà été appliquée!
- Nœuds qui sont inhérents au bois.
- Décolorations du bois qui n'exercent pas d'influences sur la durée de vie.
- Fissures / fentes de retrait qui ne sont pas traversantes et qui n'exercent pas d'influences sur la construction.
- Déformations du bois, sous réserve qu'il puisse encore être mis en œuvre.
- Sur les faces non visibles des planches du toit et du plancher, il se peut que les planches ne soient pas rabotées, on peut observer des différences de couleur et des flaches.
- Une réclamation tardive résultant d'un montage incorrectement réalisé, d'un affaissement de la maisonnette par suite de fondations et de soubassements incorrectement réalisés, est exclue.
- Une réclamation suite à des modifications apportées de son propre chef à la maisonnette, comme par exemple une déformation des madriers et des fenêtres/portes par suite d'une peinture du bois ou d'une construction insuffisantes, la fixation trop rigide du contreventement, le vissage des dormants sur les madriers, etc., est exclue.

Les recours en garantie se limitent au remplacement du matériel défectueux. Tous les autres recours sont exclus!



Peinture et entretien

Le bois est un produit naturel qui travaille de façon variable. Des caractéristiques telles que les madrures grossières et fines, les nuances de couleurs et les modifications, de même que les imbrications, ont leur origine dans la croissance du bois. Dans le cas de bois qui poussent en pleine nature, ces caractéristiques sont normales et ne doivent par conséquent pas être considérées comme des défauts mais, au contraire, comme une particularité de ce matériau naturel qu'est le bois.

Au bout de quelque temps, le bois non traité (à l'exception des longrines) prendra une teinte grise, il pourra bleuir et moisir. Pour protéger votre maisonnette en poutres, il convient que vous le traitiez avec des produits de protection du bois appropriés.

Pour protéger votre maison de jardin de façon optimale, nous vous conseillons de traiter préalablement les planches du plancher à l'aide d'un apprêt incolore. En particulier la face inférieure à laquelle vous ne pourrez plus avoir accès après le montage. Ce n'est que de cette façon que l'on empêche l'humidité de pénétrer.

Nous conseillons de traiter impérativement les portes et les fenêtres également à l'aide d'un apprêt. Il est très important de peindre en une seule fois aussi bien les faces intérieures que les faces extérieures des portes et des fenêtres! Dans le cas contraire, elles pourront se déformer.

Une fois le montage effectué, nous vous conseillons de revêtir l'extérieur (sans le toit) d'un apprêt. Dès que cet apprêt sera sec, vous devrez revêtir votre maison d'un glacis pour bois qui protégera le bois contre l'humidité et le rayonnement ultraviolet.

Pour la peinture, n'utilisez qu'un outillage et une peinture de haute qualité, et respectez les consignes de sécurité et de mise en œuvre du fabricant de peintures. Ne peignez jamais en plein soleil ou lorsque le temps est à la pluie. Faites-vous conseiller de façon détaillée par votre revendeur spécialisé quant à la protection à utiliser pour les conifères non traités.

En refaisant régulièrement la peinture, vous augmentez sensiblement la durée de vie de votre maison de jardin. Nous vous conseillons également une inspection semestrielle de votre maison de jardin.

2 Préparation au montage

Outils et préparation des détails

Pour le montage, vous avez besoin du matériel suivant:



une personne pour vous aider au montage



échelle double



marteau



niveau à bulle d'air



tournevis



scie



couteau



mètre-ruban



pince



foret

REMARQUE: Pour éviter les blessures provoquées par d'éventuels éclats de bois, nous vous demandons de porter des gants de protection correspondants lors du montage.



Nous vous souhaitons beaucoup de moments heureux, une installation réussie et beaucoup d'années joyeuses dans votre maisonnette!

1 Generalidades



Estimado cliente,

¡Nos alegra que haya elegido una casita nuestra!

¡Por favor, lea atentamente el manual de montaje antes de empezar a armarla! Esto le evitará problemas y pérdida de tiempo.

Recomendaciones:

- Hasta que empiece a armar la casa mantenga el paquete en su embalaje y en un lugar seco evitando el contacto directo con el suelo, protéjalo de la intemperie (humedad, sol, etc.) ¡No deje el paquete en lugares calientes!
- Al seleccionar la ubicación de la cabaña en su jardín, evite lugares donde quede expuesta a efectos fuertes de la intemperie (nevadas o vientos fuertes), en caso contrario será necesario fijar la casa al suelo (por ejemplo, con anclajes).



Garantía

Su casita está hecha de abeto de alta calidad y se entrega al natural (sin pulir). Si, a pesar de nuestras minuciosas inspecciones, descubriese defectos, presente llene la ficha de control y preséntela al vendedor junto con la factura.

ATENCIÓN: ¡Por favor, conserve la documentación adjunta al paquete! La ficha de control incluye el número de serie de la casita. ¡Sus quejas serán atendidas solamente si suministra al vendedor el número de control de su casita!

La garantía no cubre:

- Peculiaridades naturales de la madera
- Piezas que hayan sido pintadas (tratadas con preservantes)
- Piezas con nudos que no afectan la estabilidad de la casita
- Piezas con diferentes tonos de color debidos a la estructura de la madera y que no afectan su vida útil
- Piezas con pequeñas grietas/fisuras (causadas por el secado) que no atraviesan la pieza y no afectan la estructura de la casita
- Piezas de madera torcidas que pueden ser usadas en la casa
- Tablas del techo o suelo que, en su superficie oculta, puedan tener zonas sin pulir, variaciones de color o desgastes
- Problemas provocados por el montaje incompetente de la casita o hundimiento de la casita debido a cimentación deficiente
- Problemas causados por alteraciones arbitrarias en la casa, como deformación de las piezas de madera o de las ventanas o puertas como consecuencia del tratamiento incompetente de la madera; ajuste excesivo de los ganchos de tormenta, atornillado de los marcos de las puertas a los troncos de las paredes, etc.

Las reclamaciones por problemas cubiertos por la garantía se limitan a reemplazar los materiales deficientes / defectuosos. ¡No se aceptan otras reclamaciones!



Pintado y mantenimiento de la casa

La madera es un material natural que crece y se adapta a las condiciones climáticas. Grietas pequeñas o grandes, diferencias y cambios en los matices de colores y sus alternancias estructurales no son fallas, sino resultados del crecimiento y de las características de la madera como material natural.

Con el tiempo la madera sin procesar (excepto las vigas de cimentación) y sin usar se vuelve gris o azul y criar moho. Proteja su casa tratándola de inmediato con un preservante de maderas.

Antes de armar la casa se recomienda tratar las tablas del suelo con un agente impregnante incoloro de madera, especialmente su lado oculto, al que no tendrá acceso después de armarla. Sólo así puede proteger las tablas contra la humedad.

¡También recomendamos tratar las puertas y ventanas con un agente impregnante tanto por dentro como por fuera! De lo contrario las puertas y ventanas se pueden deformar.

Después de armar la casa recomendamos, para su acabado final, usar pintura protectora para exteriores para evitar daños por humedad y radiación UV.

Al pintar su casa utilice únicamente herramientas y pinturas de alta calidad, siga los manuales de pintura y las instrucciones de seguridad y uso del fabricante. No se debe pintar bajo luz solar intensa o bajo la lluvia. Consulte un especialista sobre pinturas para madera suave no procesada y siga las instrucciones del fabricante de la pintura.

Pintando la casa apropiadamente prolongará considerablemente su vida útil. Se recomienda revisar cuidadosamente de la cabaña cada seis meses.

2 Preparativos para el ensamblado

Herramientas y la preparación de los componentes

Para montar la casa se necesita lo siguiente:



Ayudante



Escalera



Martillo

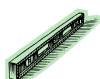

Nivel



Destornillador



Sierra



Cuchillo



Metro



Alicate



Taladro

Consejo: Para protegerse de las astillas se recomienda usar guantes protectores durante el trabajo.



¡Le deseamos éxito en el montaje de su casa y que la disfrute por muchos años!

1 In generale



Gentile Cliente,

siamo veramente lieti che Lei abbia scelto la nostra casetta di legno per il Suo giardino!

E' importante leggere accuratamente le istruzioni prima di iniziare con il montaggio della Sua casetta di legno! In tal modo eviterà qualsiasi problema e perdita di tempo.

Consigli:

- Conservare il kit in luogo asciutto e non direttamente sul pavimento, protetto da agenti atmosferici (acqua, sole ecc.) fino al montaggio definitivo. Non conservare il prodotto in ambienti riscaldati !
- Nella scelta del luogo di collocamento, fare attenzione che la casetta non sia esposta a condizioni atmosferiche estreme (vento forte); eventualmente ancorare la casetta ulteriormente con le fondamenta.



Garanzia

La vostra casetta è stata realizzata con pregiato legno di abete rosso nordico e viene consegnata in stato non trattato. Qualora, nonostante il nostro accurato controllo in fabbrica, dovessero sorgere reclami, sarà necessario presentare al negoziante il certificato di controllo compilato insieme alla fattura d'acquisto!

IMPORTANTE: E' assolutamente necessario conservare la documentazione! Sul certificato di controllo è riportato il numero di controllo della casa. Reclami possono essere evasi in garanzia unicamente se comunicherete il numero di controllo al vostro negoziante!

Divergenze che escludono motivo di reclamo:

- Il legno è un prodotto naturale e pertanto le contestazioni relative allo stato naturale non rientrano nella garanzia.
- Reclami relativi al materiale non vengono accettati una volta verniciato!
- Rami cresciuti nel legno.
- Scolorimenti del legno che non influiscono sulla durata.
- Crepe /fessure non passanti che non compromettono la costruzione.
- Nodi nel legno a condizioni che possa ancora essere lavorato.
- Nei punti invisibili del tavolame tetto e pavimento sono ammesse tavole non piallate; sono inoltre ammesse differenze di colore e spigoli dell'albero.
- Reclami successivi dovuti a montaggio non conforme, cedimento della casetta a causa di fondamenta errate sono esclusi.
- I reclami causati introducendo modifiche proprie alla casetta, p.es. deformazione di tavole e finestre/porte dovute ad un montaggio incompetente, fissaggio troppo rigido del listello antivento, avvitarmento dei telai delle porte con le tavole di legno ecc., sono esclusi.

Le rivendicazioni di garanzia sono limitate alla sostituzione del materiale difettoso. Ogni altra rivendicazione è esclusa!



Verniciatura e cura

Il legno è un prodotto naturale e si muove in modo diverso. Caratteristiche quali venature grosse e fini, sfumature di colore e cambiamenti nonché nodi sono dovuti alla crescita dell'albero. Sono del tutto normali nei legni che crescono all'aperto, e pertanto non sono da considerare difetti ma piuttosto una caratteristica del legno naturale.

Il legno non trattato (ad eccezione dei travetti) diventa grigio col tempo, può scolorirsi e fare la muffa. Per proteggere la vostra casetta di legno, è consigliabile trattarla con opportuni preservanti per legno.

Per proteggere al meglio la vostra casetta da giardino, consigliamo di trattare le tavole del pavimento preventivamente con un colore di fondo neutro, in particolare la parte inferiore che non sarà più raggiungibile dopo il montaggio. Solo in questo modo la penetrazione di umidità potrà essere evitata.

Consigliamo di trattare in ogni caso anche porte e finestre con un colore di fondo. E' molto importante verniciare sia il lato interno che quello esterno delle porte in un'unica soluzione, altrimenti potrebbero deformarsi !

Dopo il montaggio, consigliamo di applicare uno strato di fondo sulla pelle esterna (senza tetto), non appena il medesimo si sarà asciugato, verniciare la casetta con una velatura per legno per proteggere il legno dall'umidità e dalle radiazioni UV.

Per la verniciatura, usare attrezzi e vernici di qualità e rispettare le istruzioni di sicurezza e applicazione del produttore della vernice. Non verniciare in pieno sole o in caso di pioggia. Farsi consigliare dettagliatamente dal venditore sulla protezione di legni di conifera non trattati.

Con una regolare verniciatura aumenterete notevolmente la durata della vostra casetta da giardino. Consigliamo un'ispezione semestrale della casetta.

2 Preparazione al montaggio

Attrezzi e preparazione dei particolari

Attrezzi occorrenti:



aiutante



scala doppia



martello



livella a bolla d'aria



cacciavite



sega



coltello



metro



pinza



trapano

AVVERTENZA: Per evitare lesioni causate da eventuali schegge di legno, portare guanti di protezione durante il montaggio.



Vi auguriamo successo nel montaggio della casa e speriamo che la godrete per molti anni!

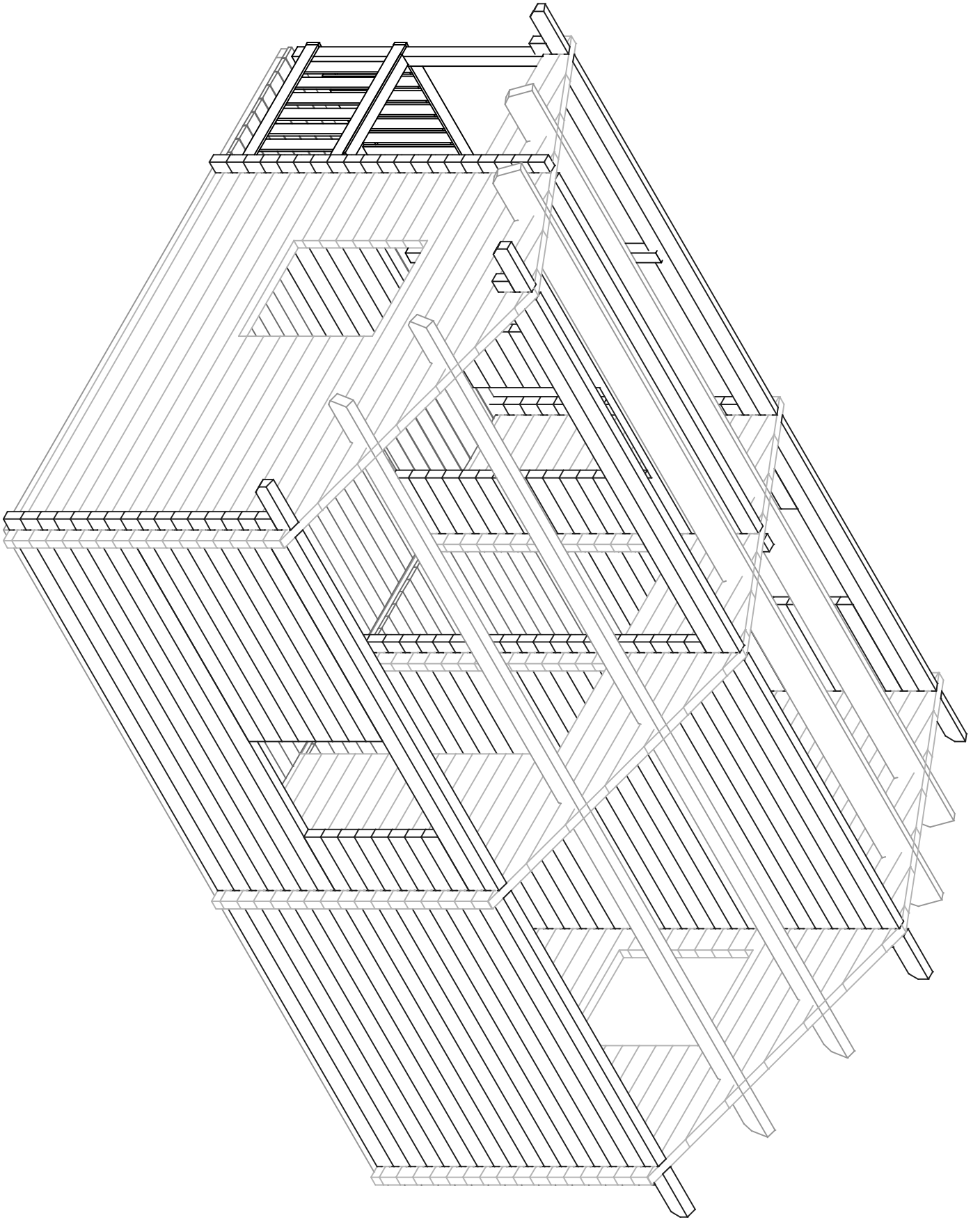

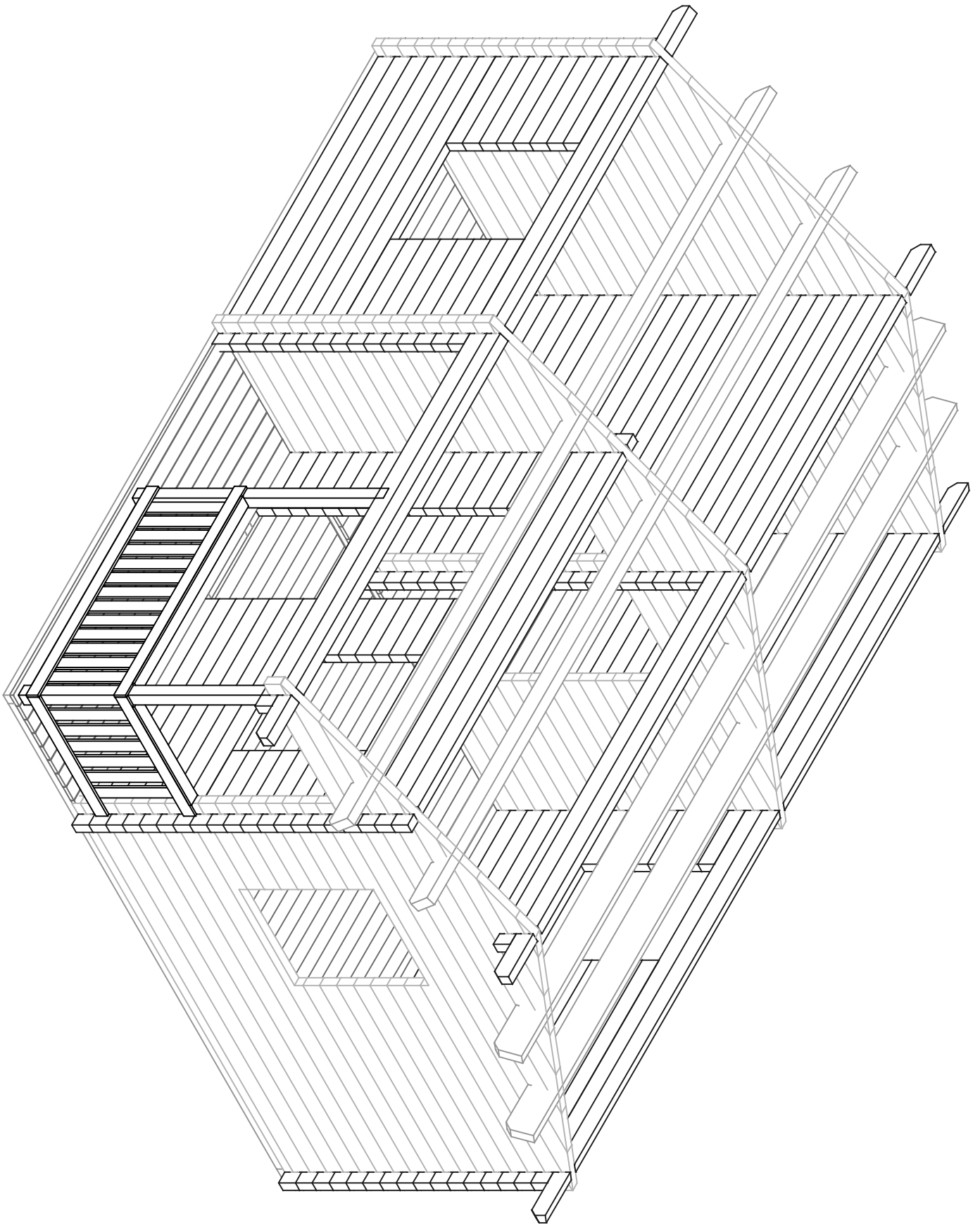

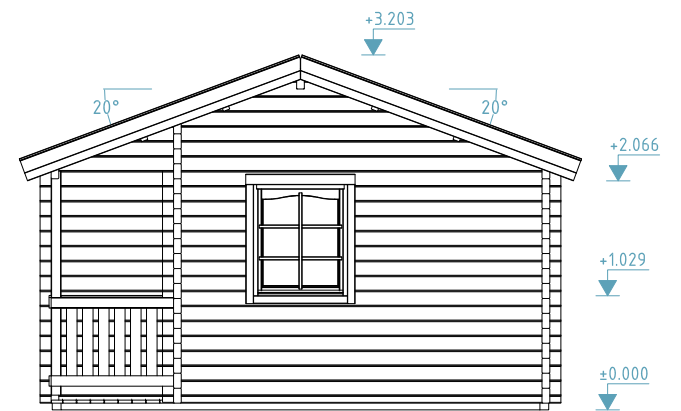
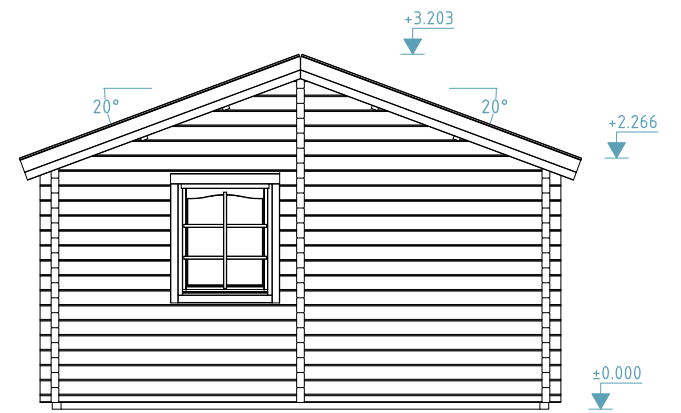

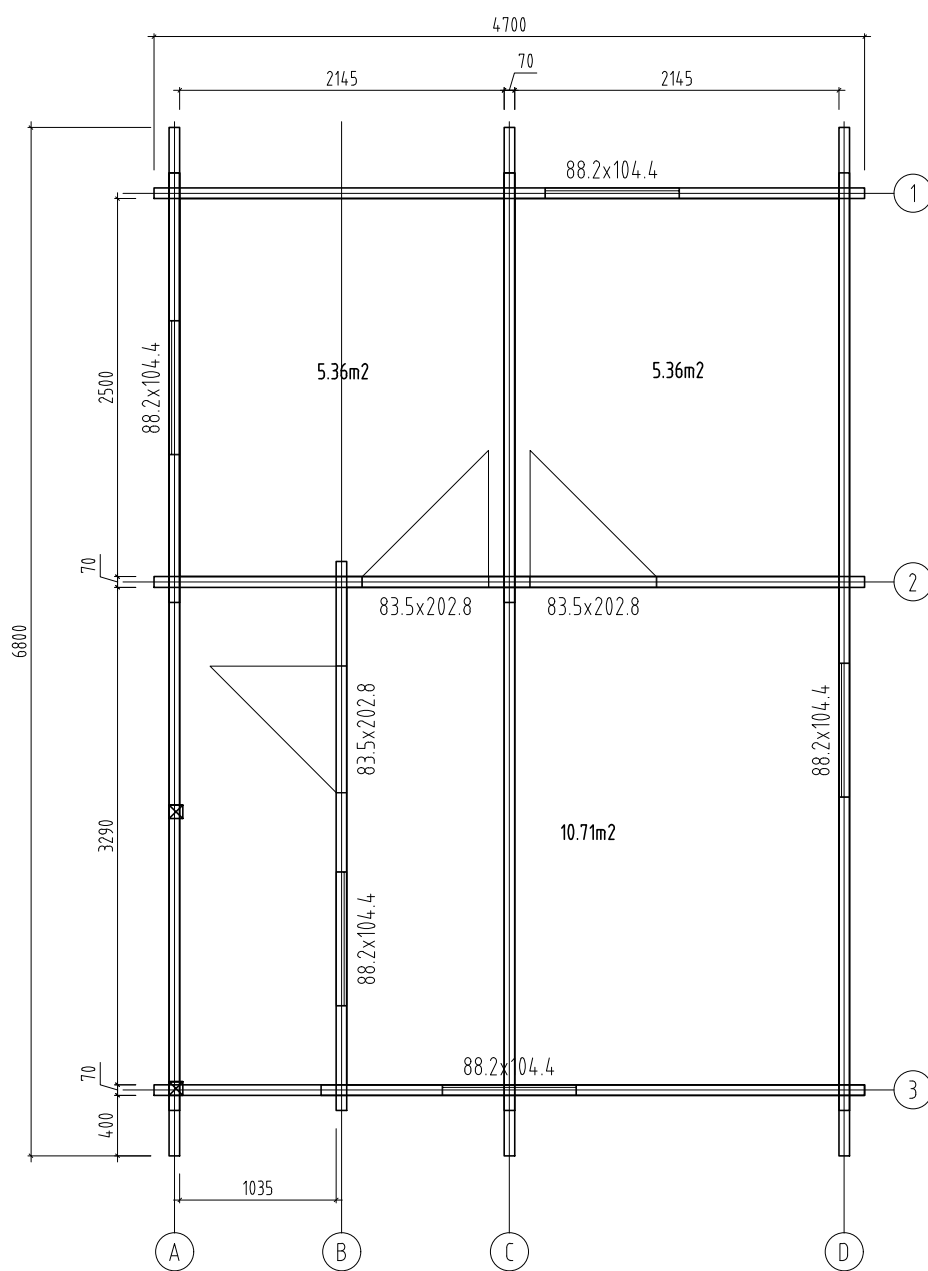

Object name
-PM70-6247-

Drawing
Plan

Scale 1:50

Paper A4

Palmako
LEMEKS GROUP

AS Palmako
Näituse 25, Tartu 50409, Estonia
tel. +372 73 55 530
fax. +372 73 55 544
www.palmako.com

Customer Erimaja

Log 70x135





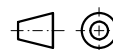

Drawn by Meelis Piirisalu

Date 26.05.2016

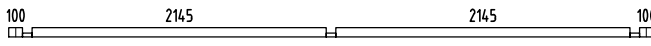
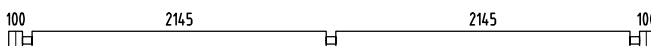
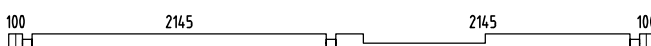
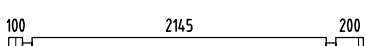
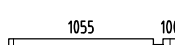
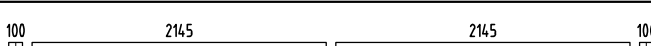
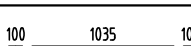

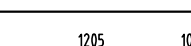
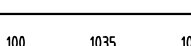

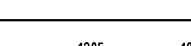
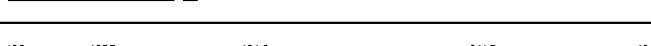
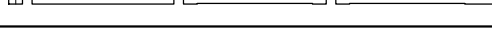
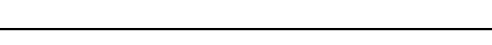
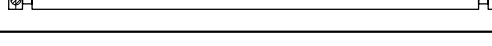
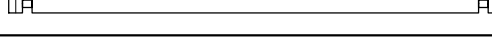
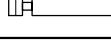
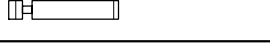
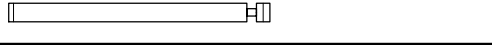
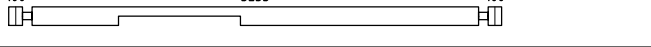
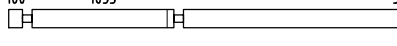
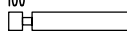

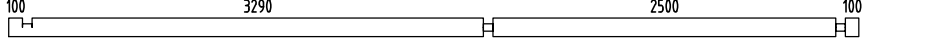

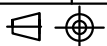

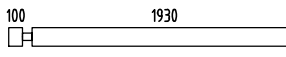
File PM70-6247.dwg

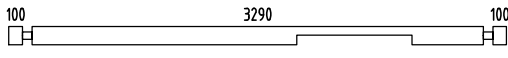
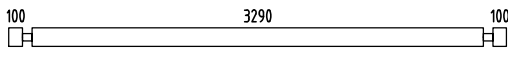
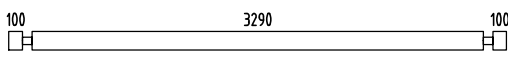
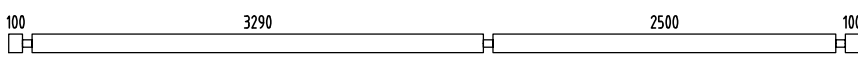

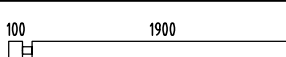
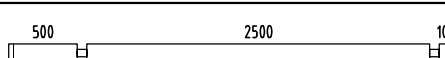
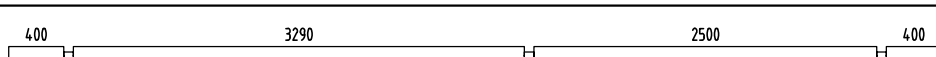
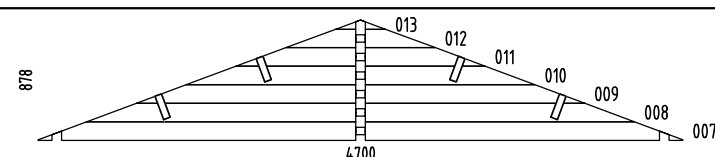
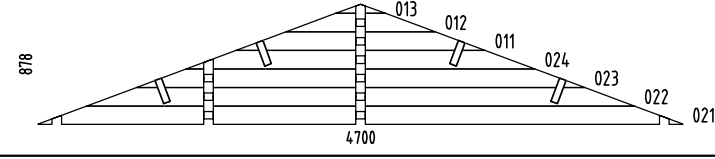
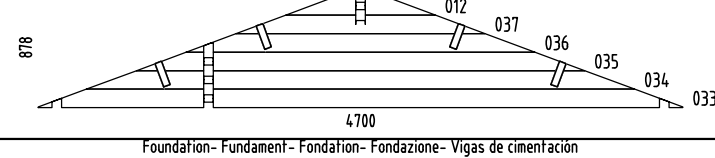
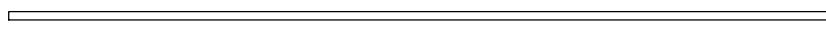
Page 1

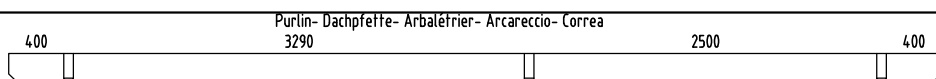
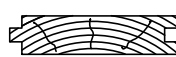
| Pos | SPECIFICATION-STÜCKLISTE-NOMENCLATURE-ELEMENTI-ESPECIFICACIÓN -PM70-6247- | Pcs | Profile (mm) | Length (mm) |
|-----|--|-----|-----------------|----------------|
| 001 |  | 1 | 70x68 | 4700 |
| 002 |  | 7 | 70x135 | 4700 |
| 003 |  | 1 | 70x135 | 4700 |
| 004 |  | 7 | 70x135 | 2585 |
| 005 |  | 7 | 70x135 | 1225 |
| 006 |  | 1 | 70x135 | 4700 |
| 014 |  | 1 | 70x68 | 1375 |
| 015 |  | 1 | 70x68 | 270 |
| 016 |  | 1 | 70x68 | 1375 |
| 017 |  | 15 | 70x135 | 1375 |
| 018 |  | 15 | 70x135 | 270 |
| 019 |  | 15 | 70x135 | 1375 |
| 020 |  | 1 | 70x135 | 4700 |
| 025 |  | 1 | 70x68 | 3595 |
| 026 |  | 1 | 70x135 | 3595 |
| 027 |  | 5 | 70x135 | 3595 |
| 028 |  | 1 | 70x135 | 3595 |
| 029 |  | 7 | 70x135 | 800 |
| 030 |  | 7 | 70x135 | 1905 |
| 031 |  | 1 | 70x135 | 3595 |
| 032 |  | 1 | 70x135 | 4700 |
| 038 |  | 28 | 70x135 | 2840 |
| 039 |  | 16 | 70x135 | 975 |
| 040 |  | 1 | 70x135 | 6200 |
| 041 |  | 1 | 70x135 | 6800 |





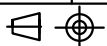



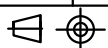



| Pos | SPECIFICATION-STÜCKLISTE-NOMENCLATURE-ELEMENTI-ESPECIFICACIÓN -PM70-6247- | Pcs | Profile (mm) | Length (mm) |
|-------|---|-----|-----------------|----------------|
| 042 |  | 7 | 70x135 | 2100 |
| 043 |  | 23 | 70x135 | 690 |
| 044 |  | 8 | 70x135 | 520 |
| 045 |  | 1 | 70x135 | 3630 |
| 046 |  | 3 | 70x135 | 3630 |
| 047 |  | 1 | 70x135 | 3630 |
| 048 |  | 9 | 70x135 | 6200 |
| 049 |  | 1 | 70x135 | 6800 |
| 050 |  | 8 | 70x135 | 2070 |
| 051 |  | 8 | 70x135 | 3240 |
| 052 |  | 1 | 70x135 | 6800 |
| W1-1 |  | 1 | | |
| W2-1 |  | 1 | | |
| W3-1 |  | 1 | | |
| AR1 | Foundation- Fundament- Fondation- Fondazione- Vigas de cimentación  | 2 | 80x60 | 5980 |
| AR3 | Foundation- Fundament- Fondation- Fondazione- Vigas de cimentación  | 11 | 80x60 | 4320 |
| AR2 | Foundation- Fundament- Fondation- Fondazione- Vigas de cimentación  | 6 | 80x60 | 581 |
| PR1 | Purlin- Dachpfette- Arbalétrier- Arcareccio- Correa  | 4 | 60x200 | 6800 |
| FB3-1 | Floor board- Fussbodenbrett- Madrier du plancher - Tavola pavimento- Tabla de suelo  | 29 | 114x28 | 3285 |
| FB3-2 | Floor board- Fussbodenbrett- Madrier du plancher - Tavola pavimento- Tabla de suelo  | 38 | 114x28 | 2495 |
| TB2-1 | Terrace board- Terrassenbrett- Madrier de terrace- Tavola terrazzo- Tabla de terraza  | 9 | 120x28 | 3355 |
| RB2-1 | Roof board- Dachbrett- Madrier du toit- Tavola tetto- Tabla de tejado  | 154 | 89x19 | 2650 |

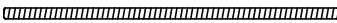

| Pos | SPECIFICATION-STÜCKLISTE-NOMENCLATURE-ELEMENTI-ESPECIFICACIÓN -PM70-6247- | Pcs | Profile (mm) | Length (mm) |
|--------------------------|---|-----|-----------------|----------------|
| FIB3-1 | Floor beading- Fussbodenleiste- Baguette du plancher- Listello pavimento- Listón de suelo | | 19x45 | 31.61 |
| CoB4-1 | Covering board- Deckbrett- Madrier de couverture- Tavola di copertura- Listón de cubierta | 20 | 19x95 | 800 |
| CoB4-2 | Covering board- Deckbrett- Madrier de couverture- Tavola di copertura- Listón de cubierta | 1 | 19x95 | 915 |
| CoB4-3 | Covering board- Deckbrett- Madrier de couverture- Tavola di copertura- Listón de cubierta | 2 | 19x95 | 1105 |
| CoB4-4 | Covering board- Deckbrett- Madrier de couverture- Tavola di copertura- Listón de cubierta | 1 | 19x95 | 1740 |
| CoB4-5 | Covering board- Deckbrett- Madrier de couverture- Tavola di copertura- Listón de cubierta | 2 | 19x95 | 1920 |
| Dia-1 | Diamond- Deckbrett- Madrier- Tavola di copertura- Rombo | 2 | 19x140 | 300 |
| EaE5-1 | Eave edging- Dachrandbrett- Madrier en bordure du toit- Tavola bordo tetto- Tabla de valadizo | 4 | 19x95 | 3400 |
| FaB7-1 | Facia board- Giebelblende- Écran frontal- Schermo frontone- Tabla de facia | 8 | 19x120 | 2690 |
| FaB5-1 | Facia board- Giebelblende- Écran frontal- Schermo frontone- Tabla de facia | 4 | 19x70 | 2690 |
| Pos3-1 | Post- Pfosten- Poteau- Montante- Poste 90x90 | 2 | 90x90 | 2020 |
| RE2-1 | Roof edge reinforcement- Dachrandleiste- Baguette en bordure du toit- Rinforzo bordo tetto- Refuerzo borde tejado | 2 | 32x40 | 3250 |
| RE2-2 | Roof edge reinforcement- Dachrandleiste- Baguette en bordure du toit- Rinforzo bordo tetto- Refuerzo borde tejado | 2 | 32x40 | 3550 |
| SlA13-1 | Slat- Leiste- Baguette- Listello- Listón | 3 | 28x70 | 840 |
| TP2-1 | Tender post- Tenderleiste- T-poste- Rinforzo- Refuerzo | 4 | 32x40 | 890 |
| TP2-2 | Tender post- Tenderleiste- T-poste- Rinforzo- Refuerzo | 6 | 32x40 | 1030 |
| TP2-3 | Tender post- Tenderleiste- T-poste- Rinforzo- Refuerzo | 2 | 32x40 | 1980 |
| TP2-4 | Tender post- Tenderleiste- T-poste- Rinforzo- Refuerzo | 4 | 32x40 | 2040 |
| Fim | -Fixing kit- Befestigungsset- Moyens de fixation- Materiale di fissaggio- Kit de fijación | 1 | | |
| QLP16 | Adjustment bolt - Senkbolzen - Boulon de réglage - Bullone di regolamento- Perno de ajuste | 2 | | |
| QPlas tikka te85mm | Covering cap - Abdeckkappe - Couvercle - Copertura- Cubierta | 1 | | |
| QUlli nkKULD | Door fittings- Türbeschlag- Ferrure- Ferramenta porta- Manilla (puerta)- | 3 | | |
| QNU35 35130 | L-iron- Winkel - Angle -Angolo- Angulo 35x35x130 EM VN353590 | 2 | | |
| QNA1 4x40M | Nail- Nagel- Clou- Chiodo- Clavo- 1.4x40mm | 60 | | |
| QNA2 2x50Zn | Nail- Nagel- Clou- Chiodo- Clavo- 2.5x50mm | 700 | | |

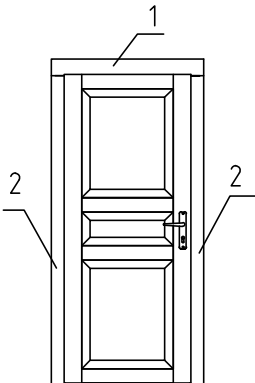
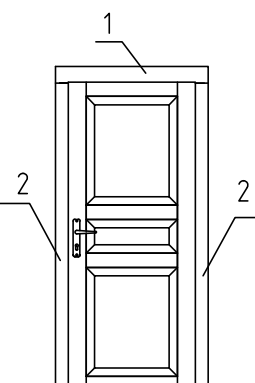

| Pos | SPECIFICATION-STÜCKLISTE-NOMENCLATURE-ELEMENTI-ESPECIFICACIÓN -PM70-6247- | Pcs | Profile (mm) | Length (mm) |
|----------------|---|-----|-----------------|----------------|
| QNA3 x70ZN | Nail- Nagel- Clou- Chiodo- Clavo- 3x70mm  | 500 | | |
| QKR3 5x40ZN | Screw- Schraube- Vis- Vite- Tornillo- 3.5x40mm  | 150 | | |
| QKR4 5x50ZN | Screw- Schraube- Vis- Vite- Tornillo- 4.5x50mm  | 400 | | |
| QKR4 5x70ZN | Screw- Schraube- Vis- Vite- Tornillo- 4.5x70mm  | 50 | | |
| QKR6x 120ZN | Screw- Schraube- Vis- Vite- Tornillo- 6x120mm  | 40 | | |
| KL1 | Threaded rod- Gewindestangen- Barre fileté- Asta filettata- Varilla roscada M10  | 6 | | 2000 |
| KL2 | Threaded rod- Gewindestangen- Barre fileté- Asta filettata- Varilla roscada M10  | 1 | | 570 |
| KL3 | Threaded rod- Gewindestangen- Barre fileté- Asta filettata- Varilla roscada M10  | 5 | | 300 |
| | Nut- Schraubenmutter- Écrou- Dado- Tuerca- M10mm  | 6 | | |
| | Washer- Dichtscheibe- Joint- Rondella- Arandela- 10x30mm  | 6 | | |
| | Extension nut- Verlängerungsmutter- Écrou rallonge- Dado di prolunga- Tuerca de extensión- JM10  | 6 | | |
| | Captive nut- Einschlagmutter- Écrou a griffes- Dado a ragno filettatura- Tuerca araña- LM10  | 6 | | |
| U-711L | Door - Tür - Porte - Porta-Puerta 835x2028  <p style="text-align: center;">U-711L Door 835x2028x72 mm</p> <p>Side slat - Randleiste Baguette en bordure - Listello bordo</p> <p>1. 19x95x1085 mm 2 pcs 2. 19x70x2025 mm 4 pcs</p> | 1 | | |
| U-711R | Door - Tür - Porte - Porta-Puerta 835x2028  <p style="text-align: center;">U-711R Door 835x2028x72 mm</p> <p>Side slat - Randleiste Baguette en bordure - Listello bordo</p> <p>1. 19x95x1085 mm 2 pcs 2. 19x70x2025 mm 4 pcs</p> | 1 | | |

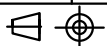

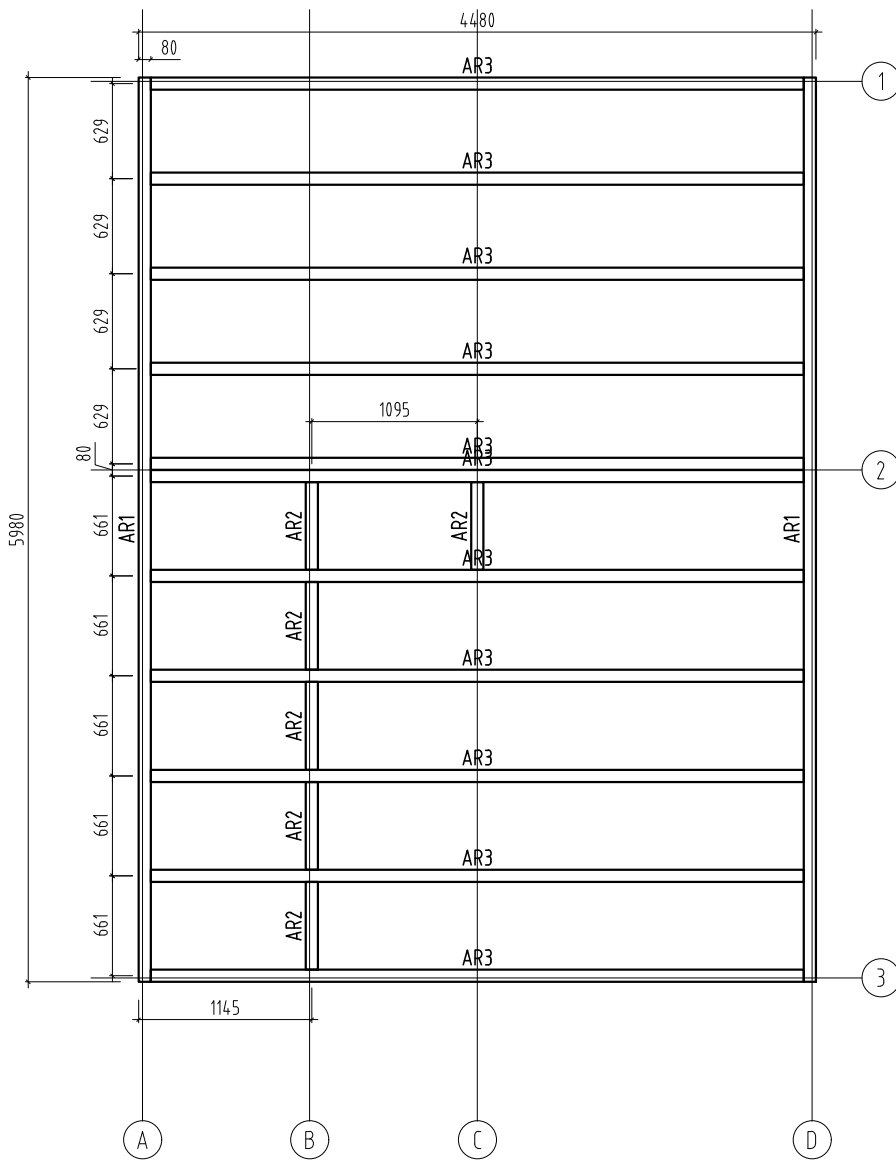

Object name
-PM70-6247-

Drawing
Plan

Scale 1:50
Paper A4

Palmako
LEMEKS GROUP

AS Palmako
Näituse 25, Tartu 50409, Estonia
tel. +372 73 55 530
fax. +372 73 55 544
www.palmako.com

Customer Erimaja
Drawn by Meelis Piirisalu
Date 26.05.2016

Log 70x135
File PM70-6247.dwg

Page 1

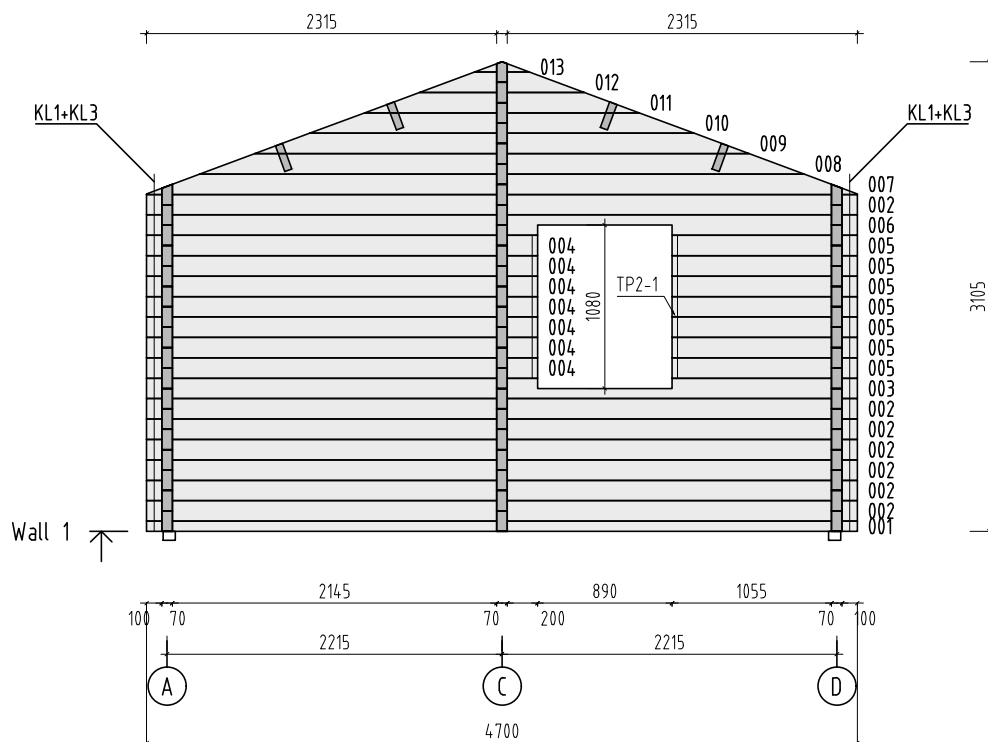

| | | | |
|--|------------------------------|-----------------------|---------------|
| Object name -PM70-6247- | Drawing WALL 1 | | Scale 1:50 |
| | | | Paper A4 |
| Palmako <small>Näituse 25, Tartu 50409, Estonia tel. +372 73 55 530 fax. +372 73 55 544 www.palmako.com</small> | Customer Erimaja | Log 70x135 | |
| | Drawn by Meelis Piirisalu | | |
| | Date 26.05.2016 | File PM70-6247.dwg | Page 6 |

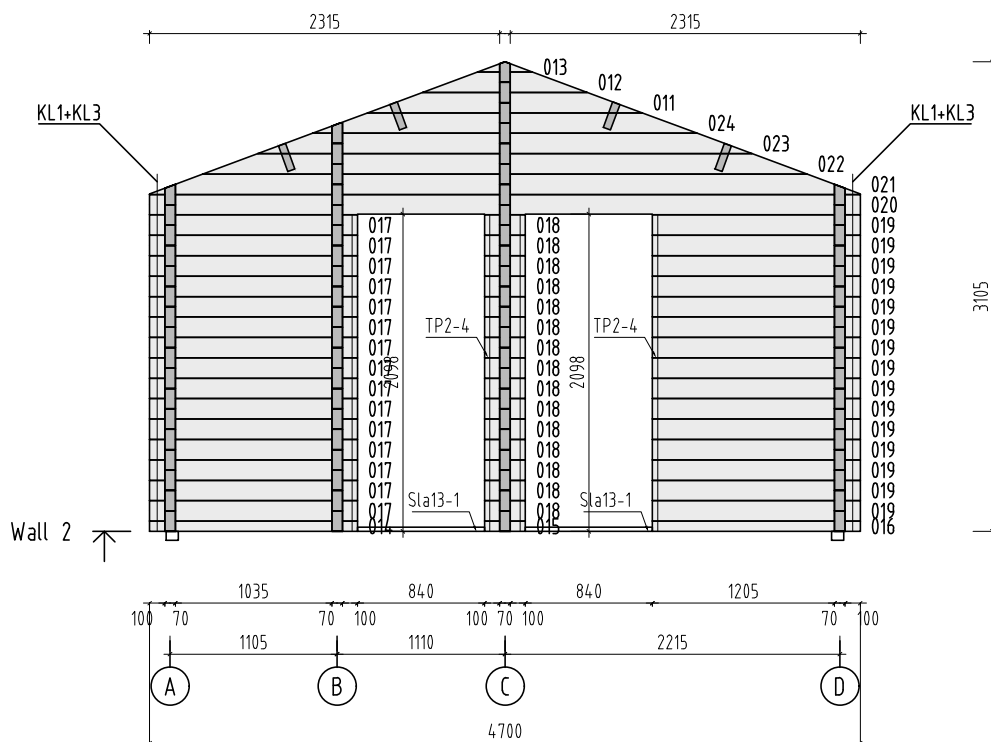

| | | | |
|--|------------------------------|-----------------------|---------------|
| Object name -PM70-6247- | Drawing WALL 2 | | Scale 1:50 |
| | | | Paper A4 |
| Palmako <small>Näituse 25, Tartu 50409, Estonia tel. +372 73 55 530 fax. +372 73 55 544 www.palmako.com</small> | Customer Erimaja | Log 70x135 | |
| | Drawn by Meelis Piirisalu | | |
| | Date 26.05.2016 | File PM70-6247.dwg | Page 7 |

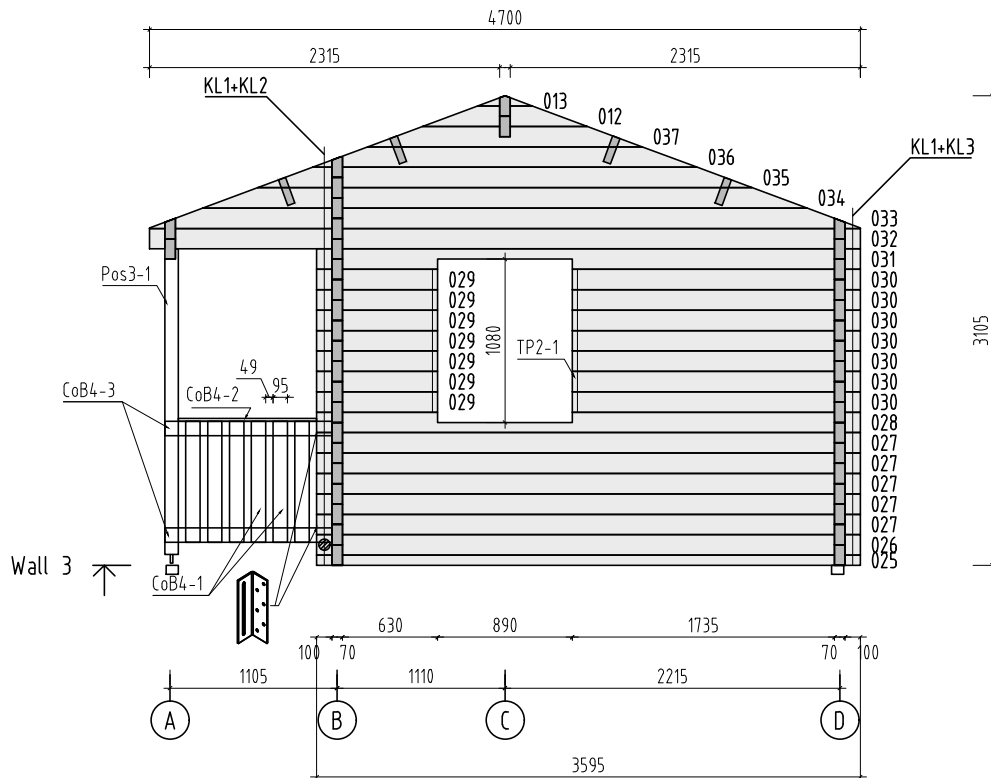

Object name
-PM70-6247-

Drawing
WALL 3

Scale 1:50
Paper A4

Palmako
LEMEKS GROUP

AS Palmako
Näituse 25, Tartu 50409, Estonia
tel. +372 73 55 530
fax. +372 73 55 544
www.palmako.com

Customer Erimaja
Drawn by Meelis Piirisalu
Date 26.05.2016

Log 70x135
File PM70-6247.dwg

Page 8

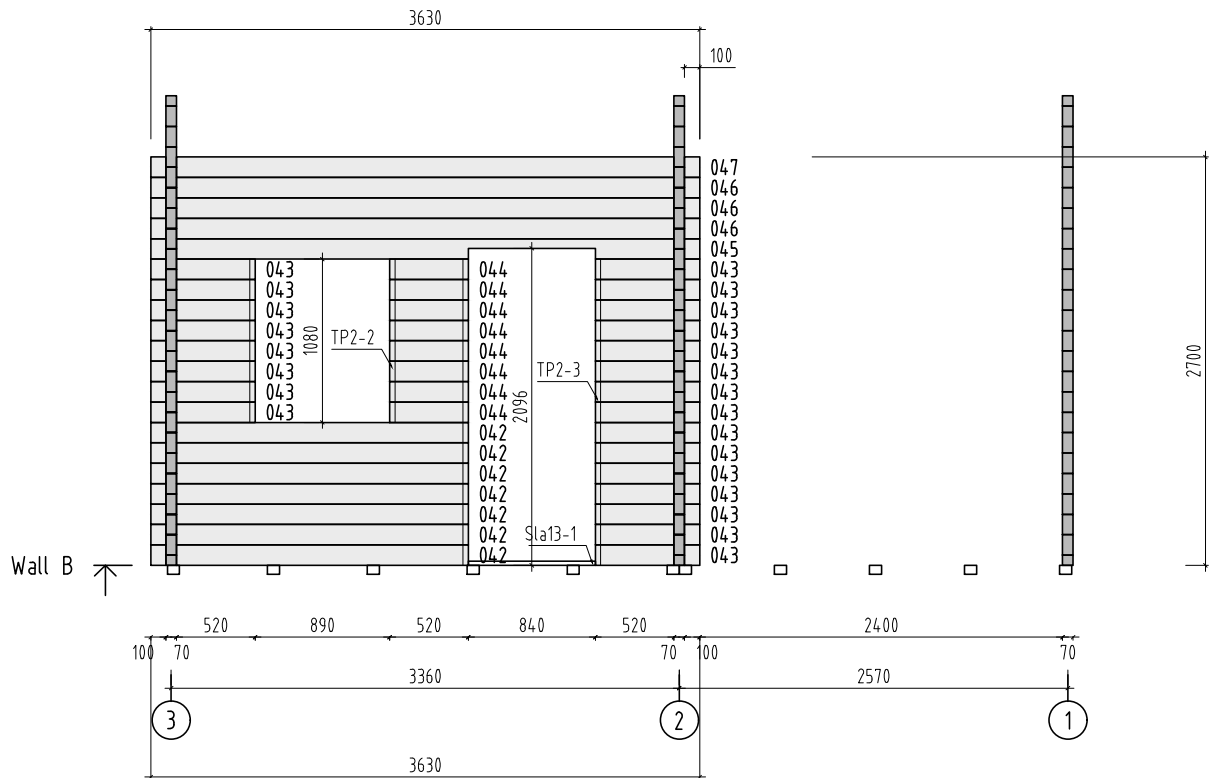

| | | | |
|--|------------------------------|-----------------------|---------------|
| Object name -PM70-6247- | Drawing WALL B | | Scale 1:50 |
| | | | Paper A4 |
| Palmako <small>Näituse 25, Tartu 50409, Estonia tel. +372 73 55 530 fax. +372 73 55 544 www.palmako.com</small> | Customer Erimaja | Log 70x135 | |
| | Drawn by Meelis Piirisalu | | |
| | Date 26.05.2016 | File PM70-6247.dwg | Page 3 |

